

DIGITAL INPUT/OUTPUT MODULE



PRODUCT DESCRIPTION

C2.DIO.12 is BACnet programmable digital input/output controller which can be used as a remote field IO in any BACnet and/or Modbus network.

TECHNICAL DATA

ELECTRICAL SPECIFICATIONS	
Power supply	24 VDC, 4 W
COMMUNICATION CHANNEL	
RS 485 primary port	BACnet MS/TP or Modbus Slave RTU/ASCII. Programmable baud rate (9600, 19200, 38400, 76800, 115200), DIP switch selectable use of termination and polarization resistors
RS 485 expansion port	Modbus Master RTU. Programmable baud rate (9600, 19200, 38400, 76800, 115200) and parity. DIP switch selectable use of termination resistor. Power supply output: 20 VDC, 100 mA
USB	USB device, mini USB connector, service port
DIGITAL INPUTS	
Potential-free inputs	16
DIGITAL OUTPUTS	
Independent NO relays, 250 VAC/5 A	4
ADDITIONAL SPECIFICATIONS	
Operating temperature	0.. +55 °C
Storage temperature	-30.. +85 °C
Operating humidity	Max 95% r.H., no condensation
Protection degree	IP20
Mounting	DIN rail, for indoor use only
Dimensions	107.6x90x62.2
Weight	250 g

PRODUCT FEATURES

- » Possibility to store operating plans in non-volatile memory
- » Programming is done using PC application
- » Configuration, programming and debugging through USB port
- » Resource sharing between controllers through BACnet network. Data sharing is performed without intervention of the supervisory system
- » RTC (real-time clock) with auxiliary power supply
- » Stand alone operation option
- » DIP switch selectable standard polarization and termination resistors on primary communication port
- » Modbus master expansion port with DIP switch selectable termination resistor and power supply output

WIRING AND RESOURCES

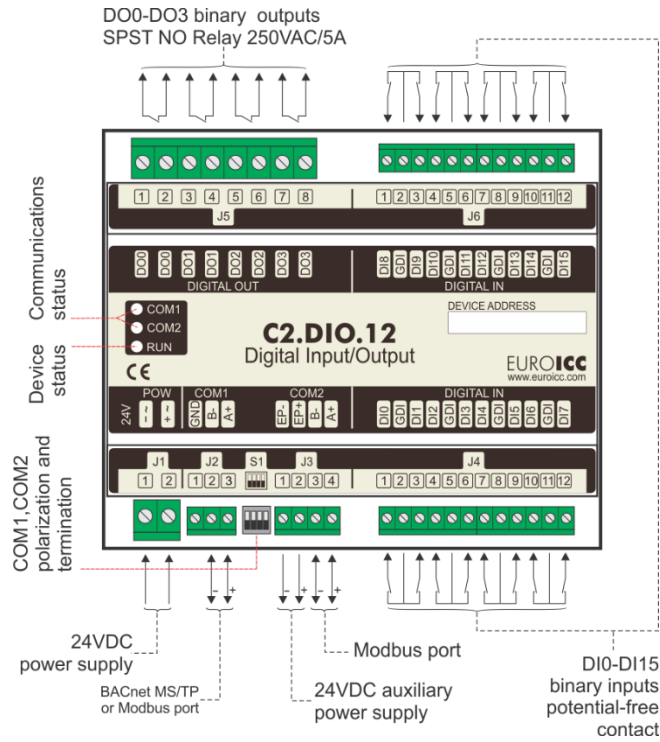

DIMENSIONS AND MOUNTING

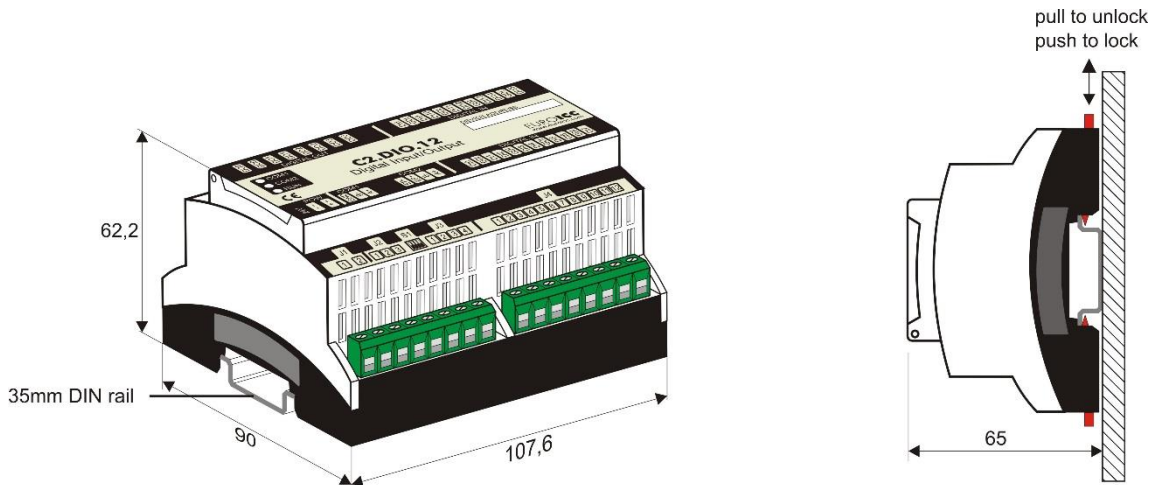

SAFETY NOTES



- The device is not allowed to be used outside the specified field of application, especially in aircraft or in any other airborne means of transport.
- It may only be installed by suitably trained personnel.
- Any legal regulations or regulations issued by authorities must be observed during assembly.
- The device may only be opened at the manufacturer's site. It does not contain any parts that can be replaced or repaired by the user.
- The device contains electrical and electronic components and is not allowed to be disposed of as household refuse. All locally valid regulations and requirements must be observed.